

**TDSHT3**  
**HDMI Compliance Test Software**  
**Quick Start User Manual**

Copyright © Tektronix, Inc. All rights reserved. Licensed software products are owned by Tektronix or its suppliers and are protected by United States copyright laws and international treaty provisions.

Use, duplication, or disclosure by the Government is subject to restrictions as set forth in subparagraph (c)(1)(ii) of the Rights in Technical Data and Computer Software clause at DFARS 252.227-7013, or subparagraphs (c)(1) and (2) of the Commercial Computer Software - Restricted Rights clause at FAR 52.227-19, as applicable.

Tektronix products are covered by U.S. and foreign patents, issued and pending. Information in this publication supercedes that in all previously published material. Specifications and price change privileges reserved.

Tektronix, Inc., P.O. Box 500, Beaverton, OR 97077

TEKTRONIX and TEK are registered trademarks of Tektronix, Inc.

## **WARRANTY 9(b)**

Tektronix warrants that the media on which this software product is furnished and the encoding of the programs on the media will be free from defects in materials and workmanship for a period of three (3) months from the date of shipment. If any such medium or encoding proves defective during the warranty period, Tektronix will provide a replacement in exchange for the defective medium. Except as to the media on which this software product is furnished, this software product is provided "as is" without warranty of any kind, either express or implied. Tektronix does not warrant that the functions contained in this software product will meet Customer's requirements or that the operation of the programs will be uninterrupted or error-free.

In order to obtain service under this warranty, Customer must notify Tektronix of the defect before the expiration of the warranty period. If Tektronix is unable to provide a replacement that is free from defects in materials and workmanship within a reasonable time thereafter, Customer may terminate the license for this software product and return this software product and any associated materials for credit or refund.

**THIS WARRANTY IS GIVEN BY TEKTRONIX WITH RESPECT TO THE PRODUCT IN LIEU OF ANY OTHER WARRANTIES, EXPRESS OR IMPLIED. TEKTRONIX AND ITS VENDORS DISCLAIM ANY IMPLIED WARRANTIES OF MERCHANTABILITY OR FITNESS FOR A PARTICULAR PURPOSE. TEKTRONIX' RESPONSIBILITY TO REPLACE DEFECTIVE MEDIA OR REFUND CUSTOMER'S PAYMENT IS THE SOLE AND EXCLUSIVE REMEDY PROVIDED TO THE CUSTOMER FOR BREACH OF THIS WARRANTY. TEKTRONIX AND ITS VENDORS WILL NOT BE LIABLE FOR ANY INDIRECT, SPECIAL, INCIDENTAL, OR CONSEQUENTIAL DAMAGES IRRESPECTIVE OF WHETHER TEKTRONIX OR THE VENDOR HAS ADVANCE NOTICE OF THE POSSIBILITY OF SUCH DAMAGES.**



# Table of Contents

General Safety Summary .....	ii
Preface .....	iii
Key Features .....	iii
Documentation .....	iii
Software Upgrades .....	iv
Contacting Tektronix .....	iv
Install the Software .....	1
Before Installation .....	1
Installation .....	1
Connect to the Oscilloscope .....	1
Start the Software .....	2
Close the Software .....	4
Get Acquainted with the Software .....	5
Use the Interface .....	5
Virtual Keyboard .....	5
Virtual Keypad .....	6
General Purpose Knob .....	7
Set Preferences .....	7
Hide and Return the TDSHT3 Software .....	8
Use the TDSHT3 Software .....	9
Tests: Process Flow .....	9
Select a Test .....	9
Configure the Test Parameters .....	10
Connect and Configure the Equipment .....	10
View the Waveform .....	11
Run the Test .....	11
Interpret the Test Result .....	12
Generate and Print a Report .....	14
Summary .....	14
Detail .....	15
Application Examples .....	18
Source: Select All (Clock-Data Tests) .....	18
Source: Inter-Pair Skew (Data-Data Tests) .....	21
Sink: Min-Diff Sensitivity Test .....	24
Sink: Jitter Tolerance Test .....	26
Cable: Eye Diagram Test .....	29
Enable Remote Control of Test Equipment .....	32
Install NI-488.2 for Windows .....	32
Connect the Equipment .....	33
Verify the Equipment Connections .....	33
Set the GPIB Bus Timing .....	34
Configure the GPIB Address .....	34
Index .....	36

## General Safety Summary

Review the following safety precautions to avoid injury and prevent damage to this product or any products connected to it.

To avoid potential hazards, use this product only as specified.

*Only qualified personnel should perform service procedures.*

While using this product, you may need to access other parts of the system. Read the *General Safety Summary* in other system manuals for warnings and cautions related to operating the system.

### To Avoid Fire or Personal Injury

**Connect and Disconnect Properly.** Connect the probe output to the measurement instrument before connecting the probe to the circuit under test. Disconnect the probe input and the probe ground from the circuit under test before disconnecting the probe from the measurement instrument.

**Observe All Terminal Ratings.** To avoid fire or shock hazard, observe all ratings and markings on the product. Consult the product manual for further ratings information before making connections to the product.

Do not apply a potential to any terminal, including the common terminal, that exceeds the maximum rating of that terminal.

**Avoid Exposed Circuitry.** Do not touch exposed connections and components when power is present.

**Do Not Operate With Suspected Failures.** If you suspect there is damage to this product, have it inspected by qualified service personnel.

**Do Not Operate in Wet/Damp Conditions.**

**Do Not Operate in an Explosive Atmosphere.**

**Keep Product Surfaces Clean and Dry.**

## Preface



The TDSHT3 HDMI Compliance Test Software is a High Definition Multimedia Interface (HDMI) Compliance Test Solution, which runs on a Tektronix oscilloscope. This software helps you perform HDMI physical layer validation and compliance testing.

## Key Features

- Conformance to HDMI 1.0 standards and test specifications (CTS version 1.1) ensures reliable results
- Complete validation to standards with wide range of tests for source, sink, and cable devices
- Accurate source tests using precise measurement techniques
- Dependable sink tests with closed-loop measurements that eliminate nonlinearities in test setup
- Automated sink and cable tests with remote control of signal sources
- Automatic mask fit, measurements, and pass or fail notification
- In-depth analysis with statistical analysis and mask margins
- One-button selection of multiple tests
- One-button csv-format summary and reports
- Complete compliance solution with an elaborate test fixture, signal sources, and TDR

## Documentation

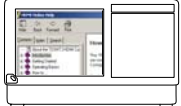
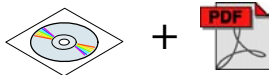
This manual describes the installation and basic operation of the TSDHT3 software. For more detailed information, see the online help. The following information is available for this product:

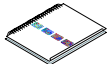
TDSHT3 Online Help	 <p>Start &gt; Programs &gt; TekApplications &gt; TDSHT3 &gt; Help</p>
TDSHT3 Online Help (PDF) TDSHT3 Quick Start User Manual, English (PDF) TDSHT3 Quick Start User Manual, Japanese (PDF) TDSHT3 Quick Reference Card, Source Test (PDF) TDSHT3 Quick Reference Card, Sink Test (PDF)	 <p>(Documents folder)</p>  <p>C:\TekApplications\TDSHT3\Manuals    <a href="http://www.Tektronix.com">www.Tektronix.com</a></p>
Installation Manual: <i>Optional Application Software on Windows-Based Oscilloscopes</i>	

## Software Upgrades

Periodic software upgrades may become available. Note that the software is only operational if you have a valid option key for the specific oscilloscope model and serial number.

To check for upgrades:

1. Go to the Tektronix Web site ([www.tektronix.com](http://www.tektronix.com)).
2. Select **Software and Drivers**.
3. Enter the product name (**TDSHT3**).

## Contact Tektronix

Phone	1-800-833-9200 <sup>1</sup>
Address	Tektronix, Inc. 14200 SW Karl Braun Drive P.O. Box 500 Beaverton, OR 97077 USA
Web site	<a href="http://www.tektronix.com">www.tektronix.com</a>
Sales support	1-800-833-9200, select option 1 <sup>1</sup>
Service support	1-800-833-9200, select option 2 <sup>1</sup>
Technical support	Email: <a href="mailto:techsupport@tektronix.com">techsupport@tektronix.com</a>  1-800-833-9200, select option 3 <sup>1</sup> 6:00 a.m. - 5:00 p.m. Pacific time

<sup>1</sup> This phone number is toll free in North America. After office hours, please leave a voice mail message. Outside North America, contact a Tektronix sales office or distributor; see the Tektronix Web site for a list of offices.



## Install the Software

The TDSHT3 software must be installed on a Tektronix oscilloscope. The following models are supported:

- TDS7704B
- TDS7404/B
- CSA7404/B
- TDS7254/B
- TDS6604B
- TDS6804B
- TDS6124C
- TDS6154C

## Before Installation

- TekVisa must be installed on the oscilloscope. If you do not have TekVisa, you can download it from the Tektronix Web site, in the same location as for *Software Upgrades* (see page iv).
- Please read the Readme.txt file on the product software CD before you install the software.

## Installation

1. Close all applications.
2. Insert the product software CD into the CD drive of the oscilloscope.
3. The installation wizard will guide you through the installation. If this is a version upgrade, the existing software will be automatically removed before the new version is installed.
4. The software files will be installed at C:\Program Files\TekApplications\TDSHT3.

## Connect to the Oscilloscope

The various tests require specific equipment setups and specific test adapters. Click **More** within the connect pane to see how to connect the device under test and test equipment to your oscilloscope. The following test adapters are required:

- Tektronix HDMI TPA-P-DI (for Differential Source tests)
- Tektronix HDMI TPA-P-SE (for Single-Ended Source tests)
- Tektronix HDMI TPA-P-TDR (for TDR tests)
- Tektronix HDMI TPA-R-DI (for Cable tests and Sink tests)
- Tektronix HDMI TPA-R-SE (for Cable tests and Sink tests)
- Tektronix HDMI TPA-R-TDR (for TDR tests and Sink tests)

## Start the Software

To start supported 7000-series oscilloscopes:

1. From the oscilloscope menu, select **File > Run application > HDMI Compliance Test Software**.

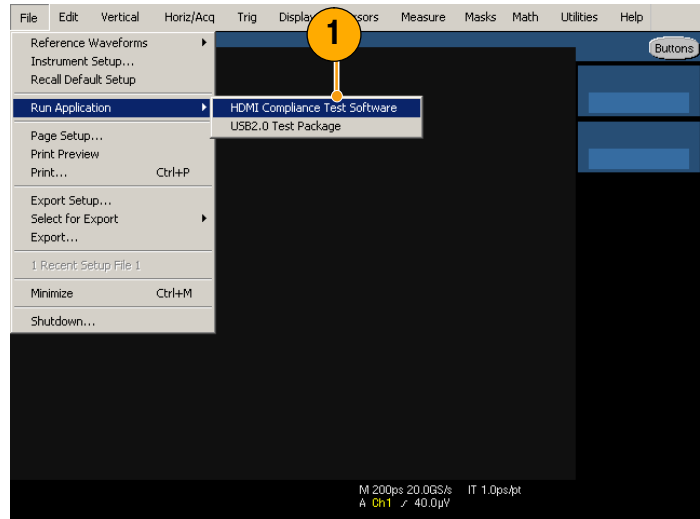

2. The oscilloscope display resizes to fit in the upper part of the screen.
3. The software displays in the lower part of the screen.
4. Proceed to step 5.

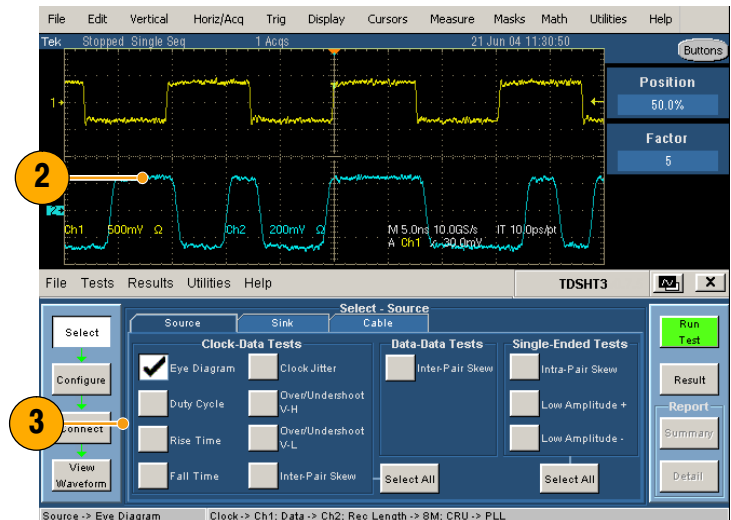

To start supported B/C-series oscilloscopes:

1. Select **App > HDMI Compliance Test Software**.

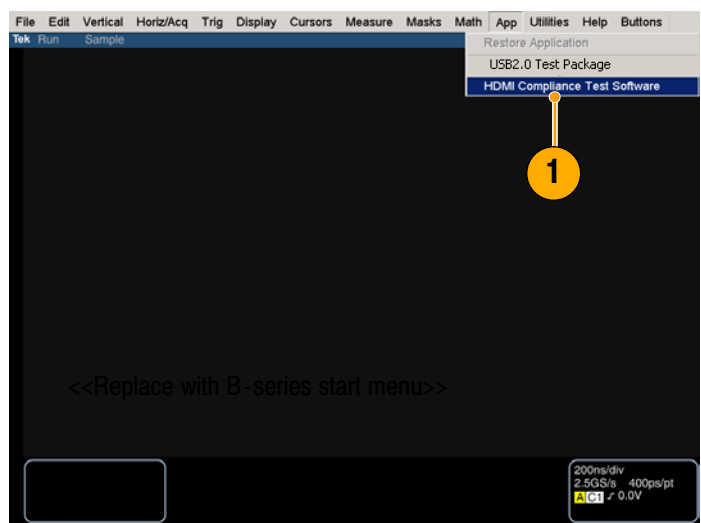

2. The oscilloscope display resizes to fit in the upper part of the screen.
3. The software displays in the lower part of the screen.
4. Proceed to step 5.

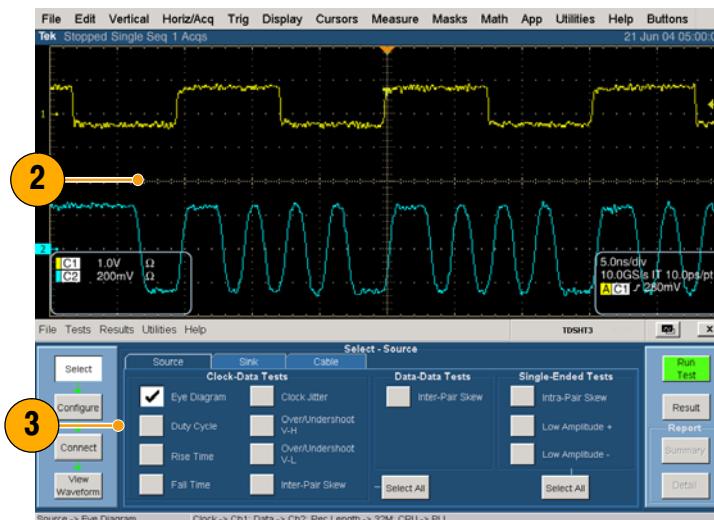

**NOTE.** To ensure accurate results, calibrate the probes and the oscilloscope before you run tests.

5. Click **Utilities > Instrument Calibration** to begin calibrating the oscilloscope for signal path compensation.
6. Click **Calibrate**.



7. Select **Vertical > Probe Cal** to begin calibrating the probes.
8. Connect the probe calibration signal to the probe.

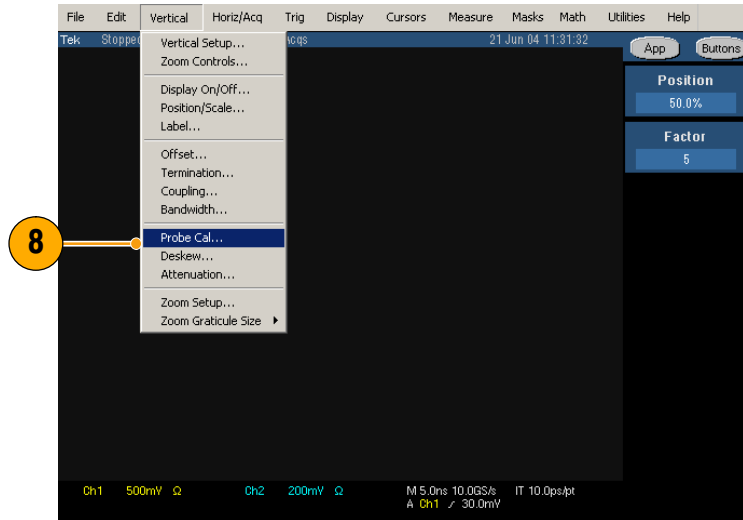

9. Click **Calibrate Probe**.

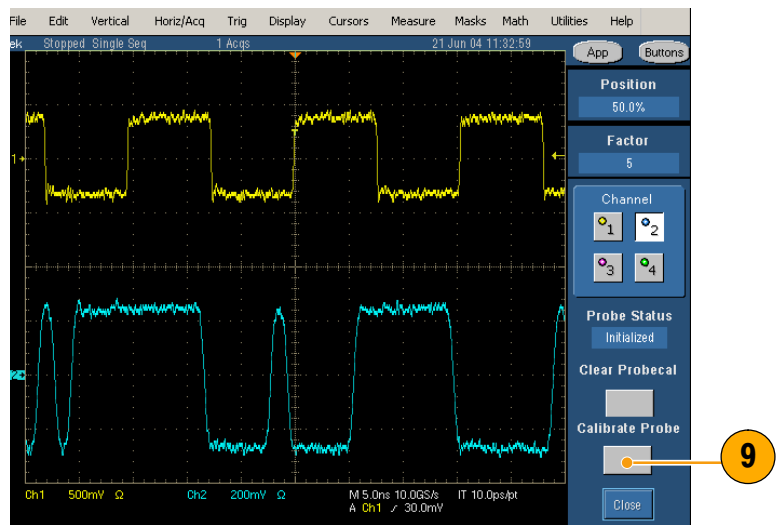

## Close the Software

1. Select **File > Exit**.
2. You can also click the exit icon.

Using other methods to exit the software will result in abnormal termination.

3. When you exit the software, you can restore the oscilloscope to the settings that were in place before the TDSHT3 software changed them.

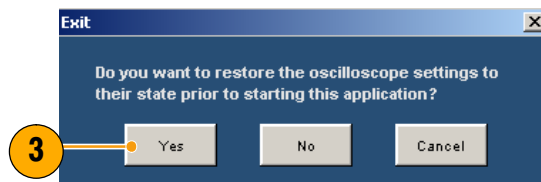
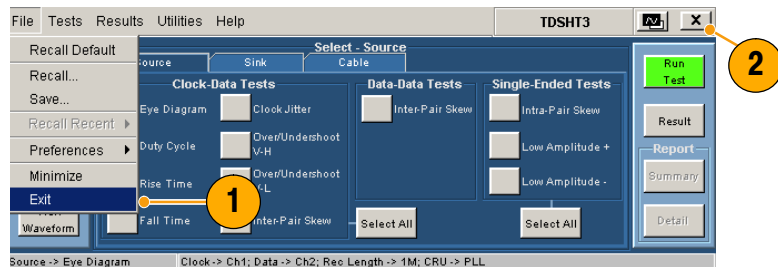

# Get Acquainted with the Software

## Use the Interface

Use a keyboard, mouse, or touchscreen to make selections in the TDSHT3 software.

Use menus, check boxes, and on-screen buttons to control the software functions. Use Microsoft Windows techniques to navigate menus and select or clear check boxes.

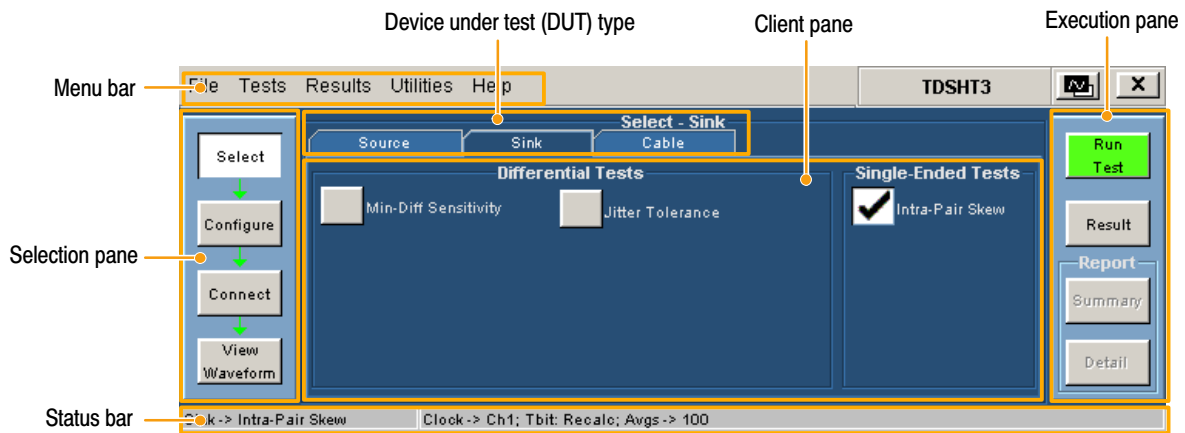

## Virtual Keyboard

1. Click a keyboard icon.

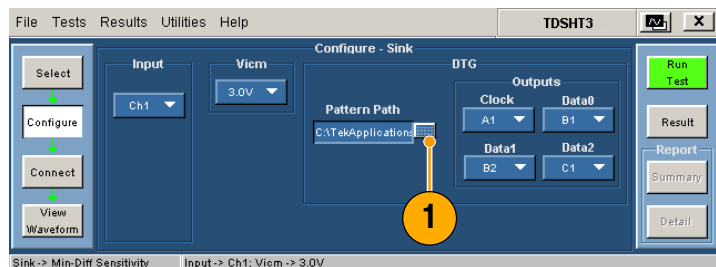

2. Clear the existing text and type the new text.
3. Click **Enter** to confirm your selection.

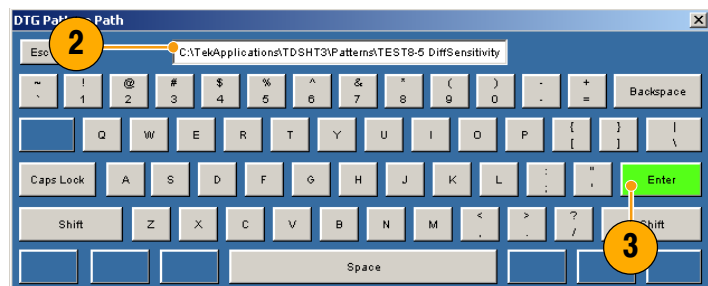

**NOTE.** You must click **Enter** on the virtual keyboard; otherwise your selections are not valid.

## Virtual Keypad

1. Click any number box.
2. Click the keypad icon.
3. Clear existing value and enter the desired value.
4. Select a unit of measure.
5. Click **Enter** to confirm your selection.

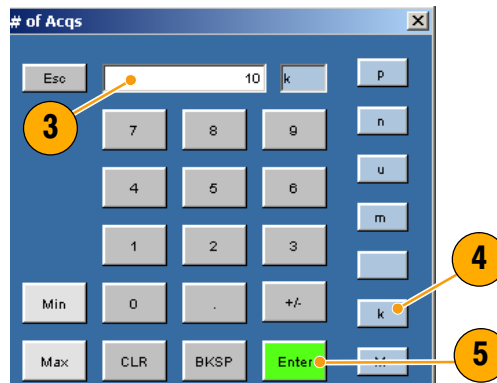
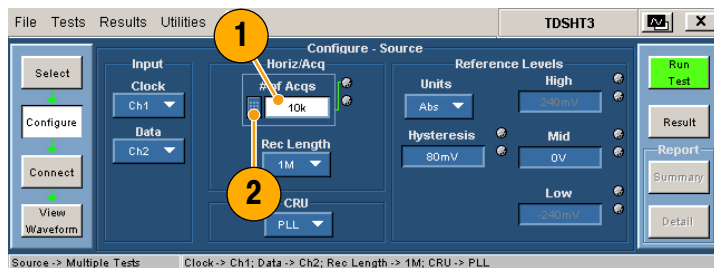

**NOTE.** You must click **Enter** on the virtual keypad; otherwise your selections are not valid.

## General Purpose Knob

1. Click any number box to display the connection to one of the general purpose knobs.
2. Turn the corresponding knob on the oscilloscope front panel to adjust the value for the selected parameter.
3. For better resolution, press the **FINE** button.

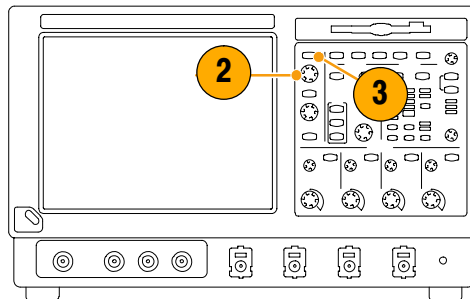
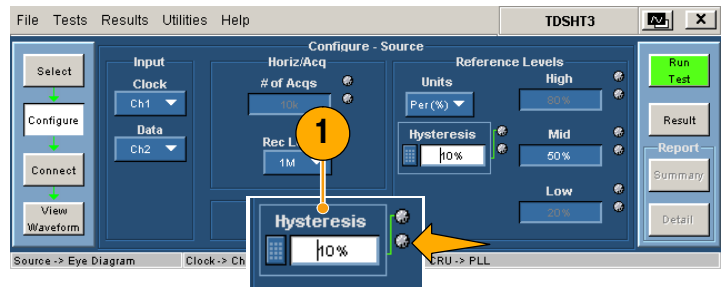

## Set Preferences

1. From the TDSHT3 software menu bar, click **File > Preferences**, and then select an option.
2. Click the option again to clear the selection.

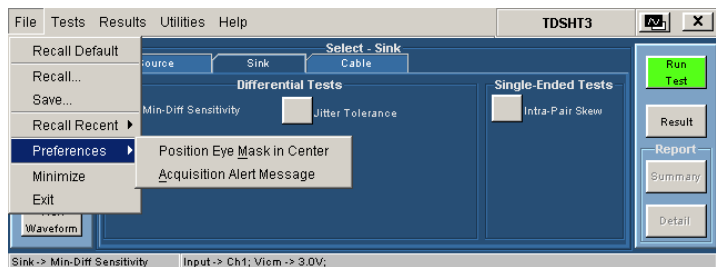

Option	Description
Position Eye Mask in Center	Selected: Positions the mask at the center of the eye diagram. Cleared: Positions the mask to the left of the eye diagram.
Acquisition Alert Message	Selected: An alert prompts you to specify oscilloscope settings with which to run the test. Cleared: TDSHT3 software selects oscilloscope settings.
Trigger Rise/Fall Time or Over/Undershoot (Available for B/C-series oscilloscopes only)	These tests can be run with a width trigger or an edge trigger (default). If the signal has very high intersymbol interference (ISI), use the width trigger.

## Hide and Return the TDSHT3 Software

1. Click the **hide** icon to minimize the TDSHT3 software and enlarge the oscilloscope display.

To return to the TDSHT3 software:

2. For 7000-series oscilloscopes, select the **APP** button.

3. For 6000B/C and 7000/B-series oscilloscopes, select **App > Restore Application**.

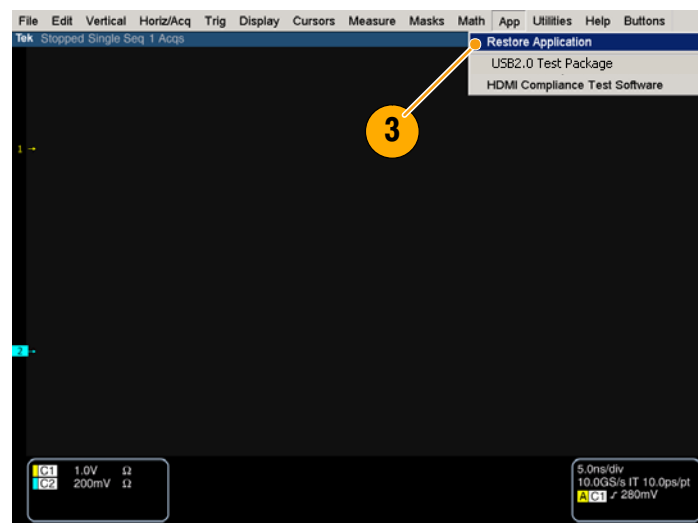
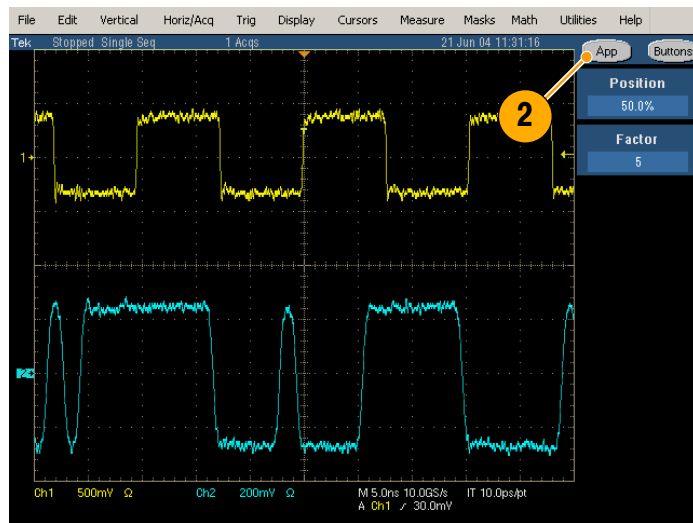
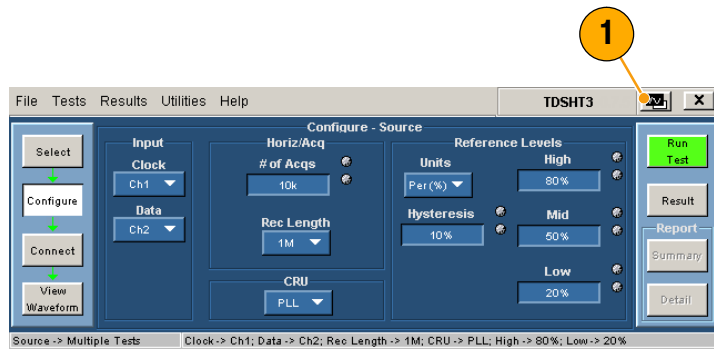



# Use the TDSHT3 Software

## Tests: Process Flow

When you make a test, follow the sequence of actions indicated in steps 1 through 6. Details for each of these actions are given on the following pages.

1. Select a test.
2. Configure the test parameters.
3. Connect and configure the equipment.
4. View the waveform to verify test signal.
5. Run the test.
6. Interpret the test result.
7. Generate a report.

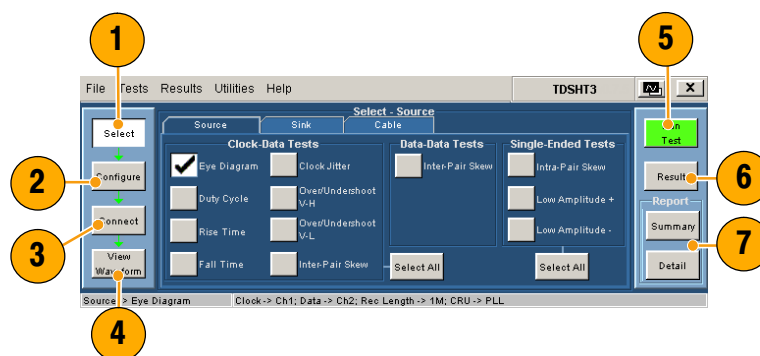

**NOTE.** For accurate test results, calibrate the oscilloscope and probes before you begin the tests. See page 3.

## Select a Test

1. Click **Select**.
2. Click the **Source**, **Sink**, or **Cable** tab.
3. Move the mouse near a test name until the test ID appears. This ID corresponds to the Test ID in the HDMI Compliance Test Specifications.
4. Select the test that you want to run.  
You can select multiple tests, but they must all be of the same type.
5. To select all tests of a certain type, click **Select All**.

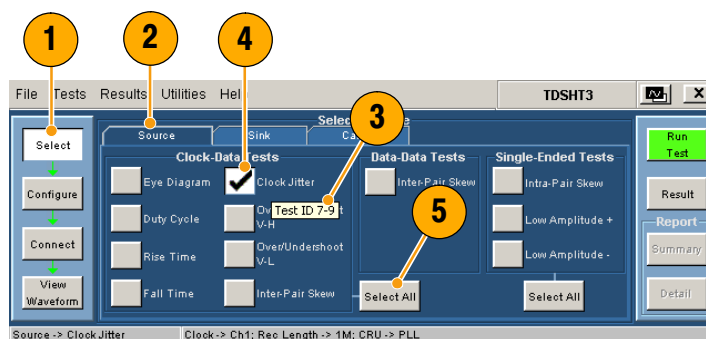

## Configure the Test Parameters

1. Click **Configure**.
2. Use the virtual keyboard or the general purpose knob on the oscilloscope front panel to change the values if necessary.

You can also use the File menu to restore factory defaults or save and recall your own configuration settings.

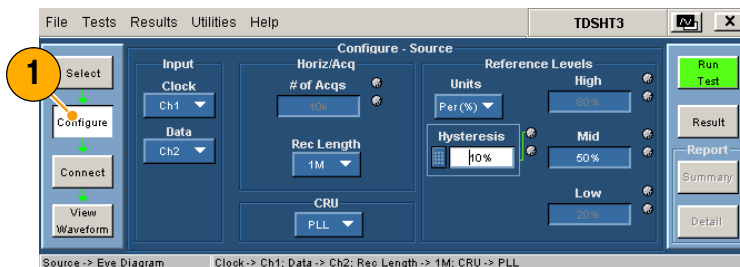

## Connect and Configure the Equipment

**NOTE.** If your test uses remote control, the setup diagram in the online help shows how to connect the test equipment by using an E-net connection. You can either use this method or you can use the GPIB-B connection described on pages 32 through 35 of this document. Example tests are shown in the Application Examples section, starting on page 18.

1. Click **Connect**.
2. Follow the on-screen instructions to connect and configure the device under test and the test equipment.
3. Click **More** to view the online help for the selected test, which contains a set-up diagram. Connect the test equipment as shown in the diagram.
4. If the AWG and DTG are used for the selected test, select **Signal Sources** and configure the test equipment. For more information, see the remote control procedure on pages 32 through 35 of this document, or refer to the online help.

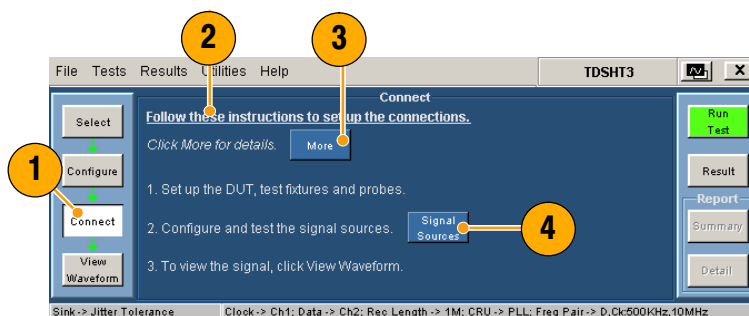

## View the Waveform

1. Click **View Waveform** (not applicable for all tests).
2. Verify that the waveform in the upper part of display is similar to the waveform that is displayed in the TDSHT3 software.

If the displays are not similar, check your configuration and connections.

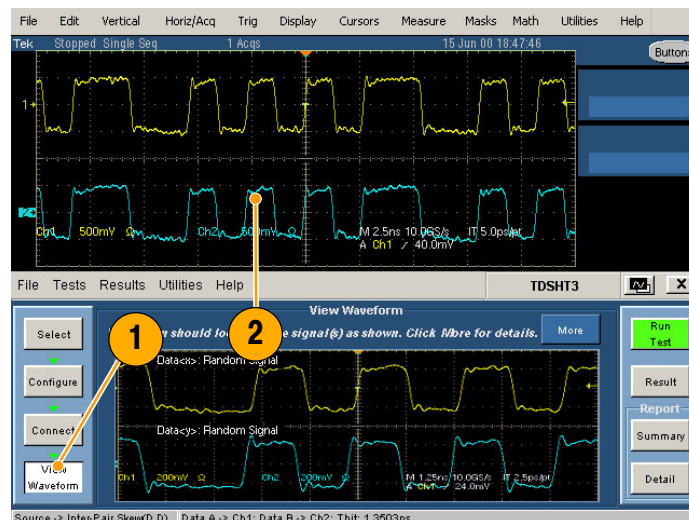

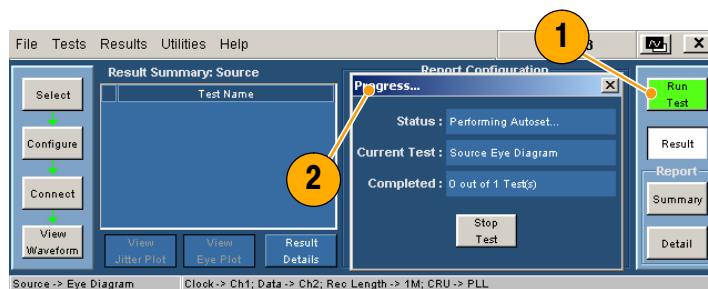

## Run the Test

1. Click **Run Test**.
2. The test will run, displaying a progress indicator.



## Interpret the Test Result

1. When the test completes, the Result Summary appears. Check to see if the device passed the test.

-  means Pass
-  means Fail
-  means Error

If the device did not pass the test, use steps 2 through 8 to solve the problem, and then rerun the test.

2. Click **Result Details** for a spreadsheet with details about the test result.
3. Check the Remarks column. If any error codes are present, see the online help for error code descriptions.

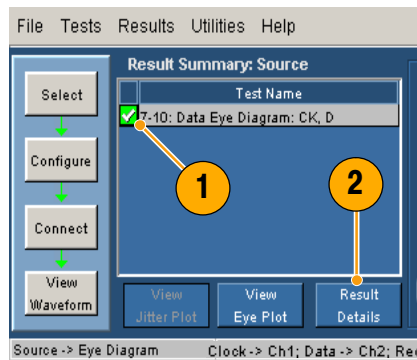

**NOTE.** The parameters in the Result Details dialog box may change depending on the test that you run.

If you ran an eye diagram test, a plot appears. You can do the following:

4. Save the image to  
C:\TekApplications\TDSHT3\Images  
(you can also change this path).
  5. Zoom in and out.
  6. View the histogram.
  7. Move the mask to see the margin of error.
  8. View statistics.
  9. Change the plot to half screen size  
(which returns the Result Summary).
10. A plot also appears if you ran the clock jitter test. In this plot, you will find the peak-to-peak jitter of the clock.

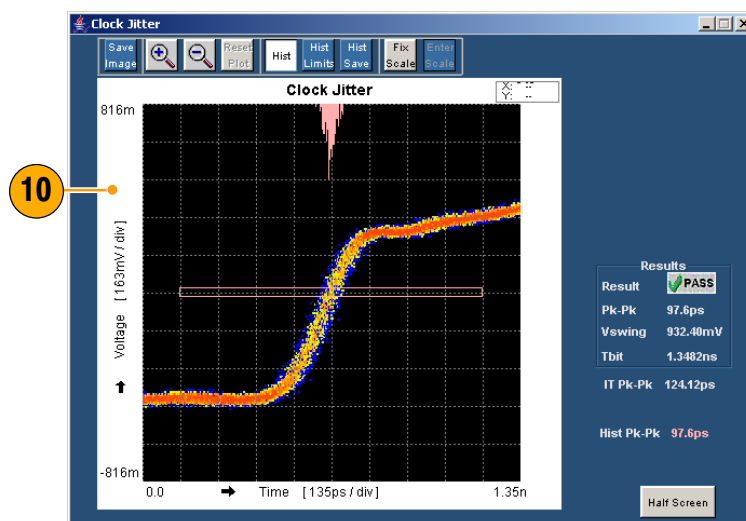
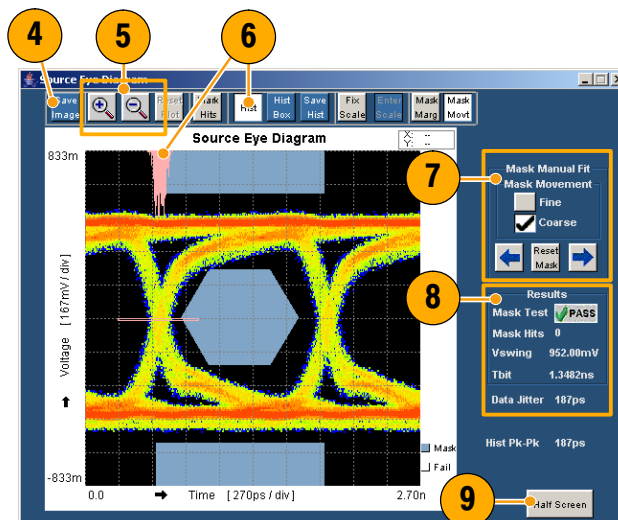

## Generate and Print a Report

You can generate and print a summary or detailed report as described here.

You can also use the Report Generator to create and print customized reports. You can save files as RTF, or in custom file formats such as RGT, RPL, and RPT. For more information about the Report Generator, see online help.

### Summary

After you have successfully run a test or tests, you can generate a report summary as a .csv file.

1. Click **Summary** in the execution pane.
2. A message indicates where the report summary is saved.
3. Open the file and print the report.

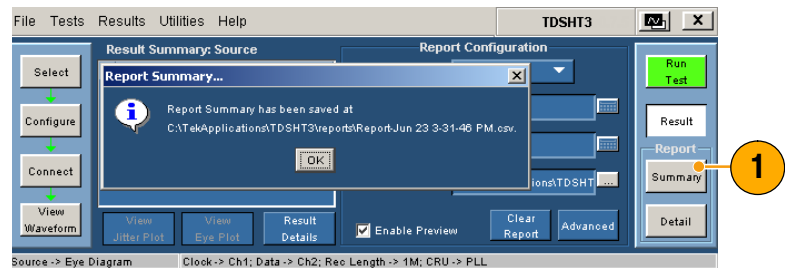

## Detail

After you run a test, you can generate a report that contains default information or information that you configure.

1. Click **Result** to begin configuring the report (or skip to step 14 for defaults).
2. Select the input on which you conducted the test.
3. Enter the resolution at which you conducted the test (such as 40 Hz, 43 Hz, 57 Hz, or 60 Hz).
4. Enter the refresh rate at which you conducted the test (such as VGA, SVGA, XGA, or SXGA).
5. Note the location where the report will be saved; you can change the location if desired.
6. Select **Enable Preview** to view the report on screen when the report is generated.
7. Click **Clear Report** to clear all reports. Reports generated between this and the next successful test run will have no values.
8. Click **Advanced**.

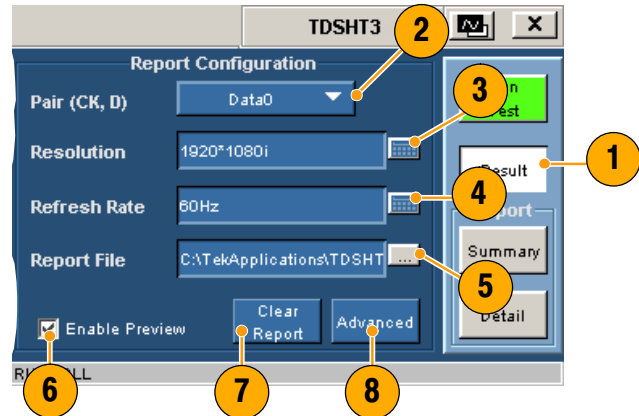

9. Enter the DUT ID (serial number).
10. Enter the DUT details (product type).
11. Enter the pair(s) that you are using for single-ended and differential tests. These entries correspond to the connectors on the HDMI adapter; see the setup diagrams.
12. When this check box is cleared, the TDSHT3 software configures the oscilloscope to display jpeg images in reports.  

If you want to change the default image export settings, change the settings in the oscilloscope image export setup and check this check box.
13. Click **OK**.

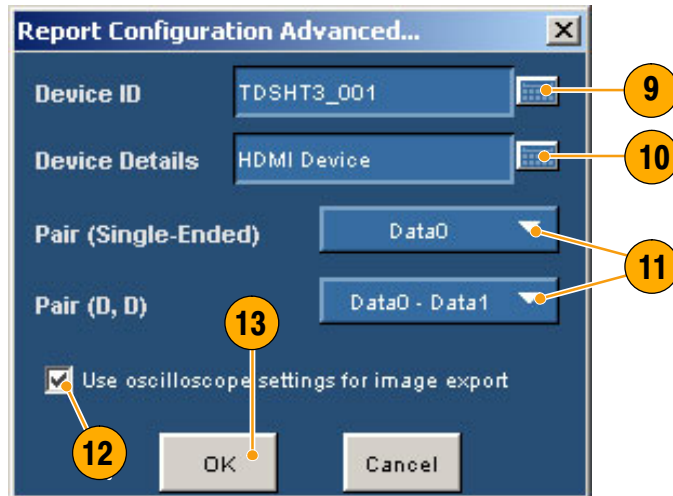



14. Click **Detail** in the report pane to generate the report.

- If **Enable Preview** is selected, the Report Viewer utility displays the report. Otherwise, a dialog box displays the location where the report was saved.
- For an eye diagram or clock jitter test, a plot is also displayed.
- You can use the Report Viewer Edit menu to edit the report, if desired.
- Use the Report Viewer File menu to print the report or export the report to an RTF file.

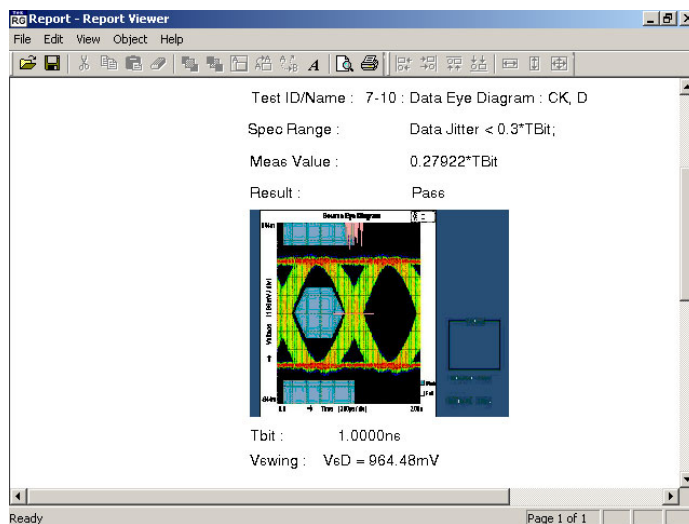

**NOTE.** The report details are real time and no history is maintained. Save the report details before making another test.

# Application Examples

## Source: Select All (Clock-Data Tests)

This selection runs a set of tests simultaneously.

Required equipment	Example
2 differential probes; Ground lead	Tektronix P7330 or later; Tektronix 196-3469-00
1 DC power supply, set to 3.3 V	Kenwood PW18-1.8AQ
1 EDID emulator	Silicon Image TE9100
1 input adapter	Tektronix TPA-P-DI
Probe Calibration and Deskew fixture	Tektronix 067-1478-xx

1. Click **Select**.
2. Click the **Source** tab.
3. Click **Select All**.

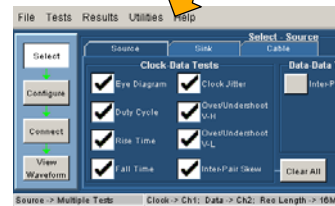
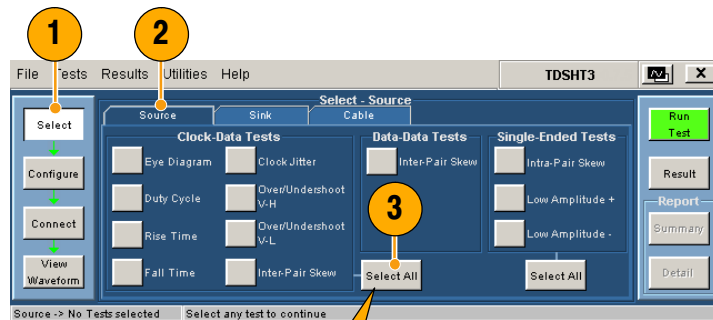

4. Click **Configure**. Change these values if needed. (You can generally use the default values.)

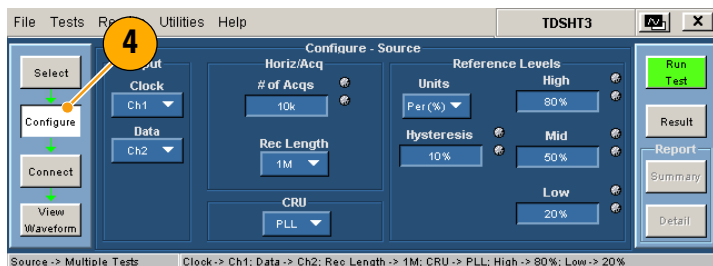

5. Click **Connect**.

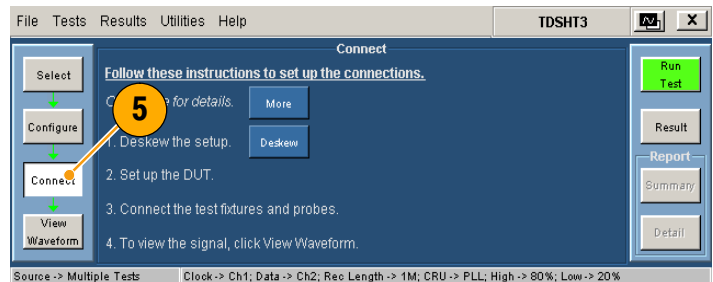

## 6. Connect and configure the equipment:

- Connect the test equipment as shown in the setup diagram.
- Configure the source DUT to output the first supported video format.
- Configure the EDID Emulator for the required resolution (refer to the EDID Emulator user manual).

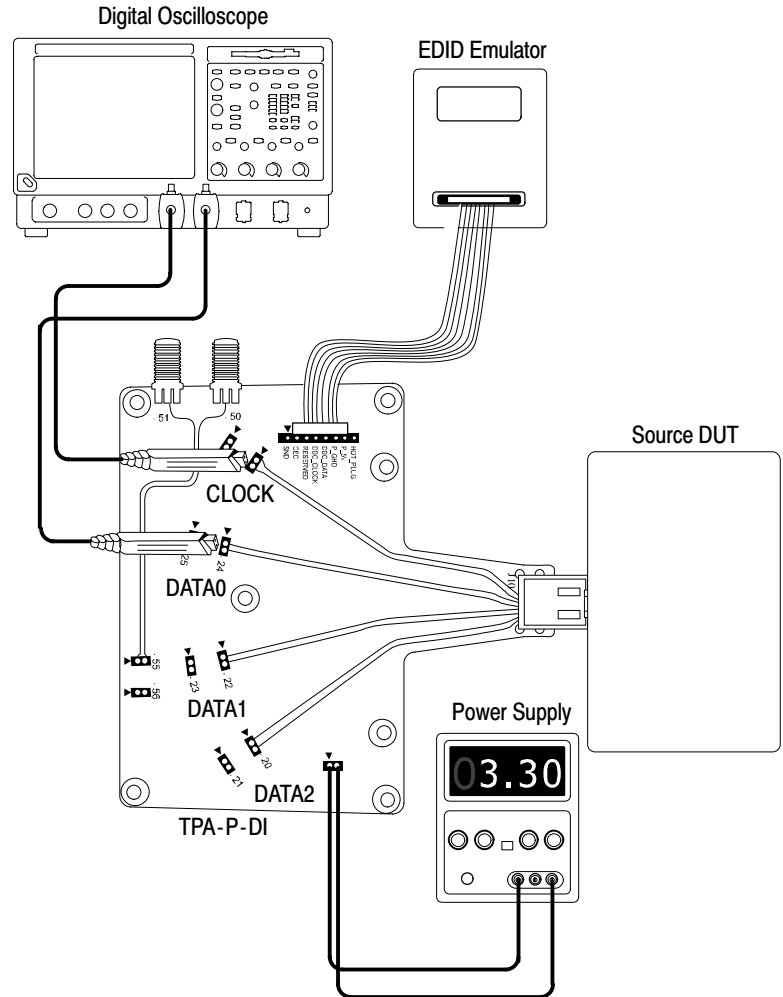

## 7. Click **View Waveform**.

Verify that the oscilloscope displays a similar waveform to the one displayed by the TDSHT3 software. If the displays are not similar, check your configuration and connections.

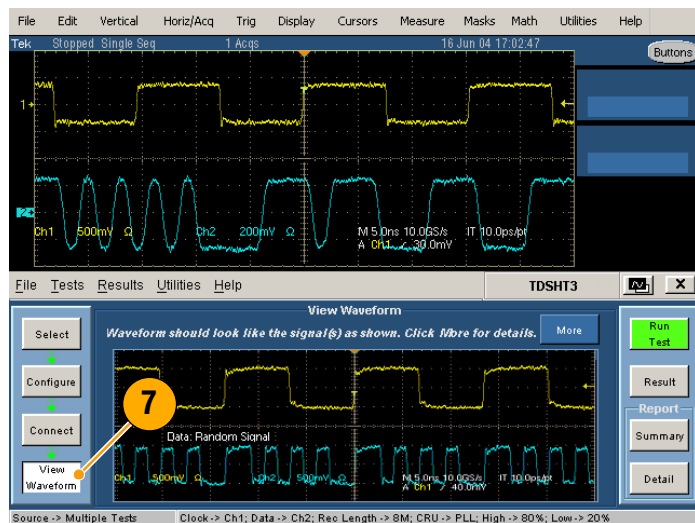

To ensure accurate results, deskew the probes before you run a test.

8. Click **Connect**.

9. Click **Deskew**.

10. Set the parameters as follows:

- Select **Internal** source for this example.
- Verify that the From channel is set to Ch1 (reference point).
- Verify that the To channel is set to Ch2 (channel to be deskewed).

11. Click **Run Test** to deskew the probes.

12. When deskew completes, click **Run Test** to run the test.

13. When the test completes, check the test results. For more information, see *Interpret the Test Result* on page 12.

14. To generate reports based on the tests that you ran, see *Generate and Print a Report* on page 14.

15. After you test the Data0 input pair, move the probe from Data0 to Data1 and repeat the test. Repeat for Data2.

16. Configure the EDID Emulator for the next pixel clock rate (VGA, SVGA, and so on), and test for all three data input pairs. Only one video format is required per pixel clock rate.

17. Repeat step 16 for all supported pixel clock rates.

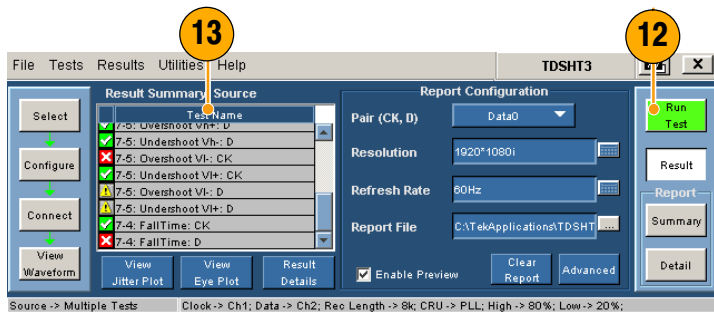
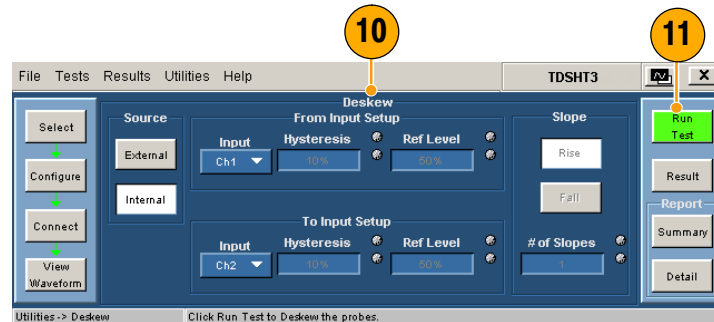
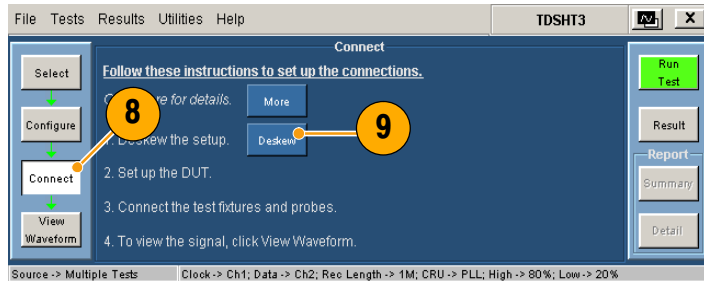

## Source: Inter-Pair Skew (Data-Data Tests)

This test verifies that the skew between the differential pairs in the TMDS portion of the HDMI link is within the limits stated in the HDMI Specifications.

Required equipment	Example
2 differential probes; Ground lead	Tektronix P7330 or later; Tektronix 196-3469-00
1 DC power supply, set to 3.3 V	Kenwood PW18-1.8AQ
1 EDID emulator	Silicon Image TE9100
1 input adapter	Tektronix TPA-P-DI

1. Click **Select**.
2. Click the **Source** tab.
3. Select **Inter-Pair Skew**.

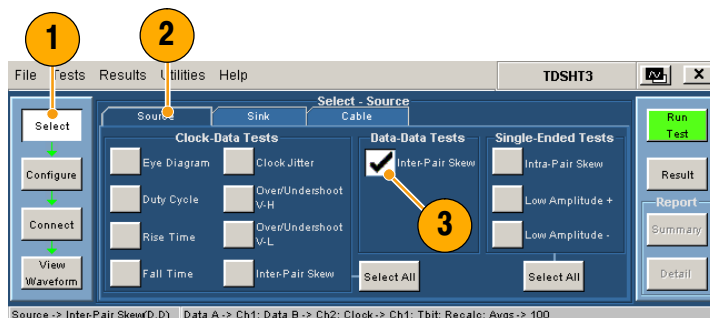

4. Click **Configure**. Change these values if needed. (You can generally use the default values.)

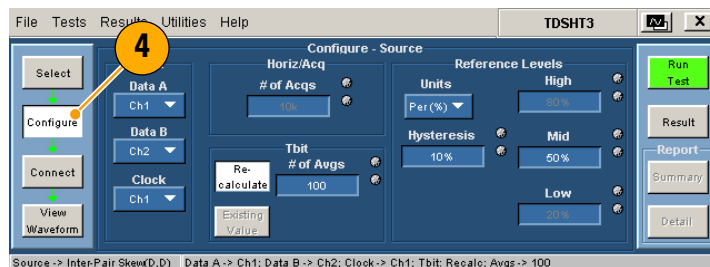

5. Click **Connect**.

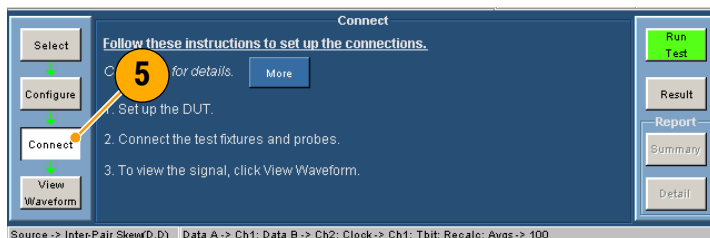

6. Connect and configure the equipment:

- Connect the test equipment as shown in the setup diagram.
- Configure the source DUT to output a video format with the highest supported pixel clock frequency.
- Configure the EDID Emulator for the required resolution (refer to the EDID Emulator user manual).

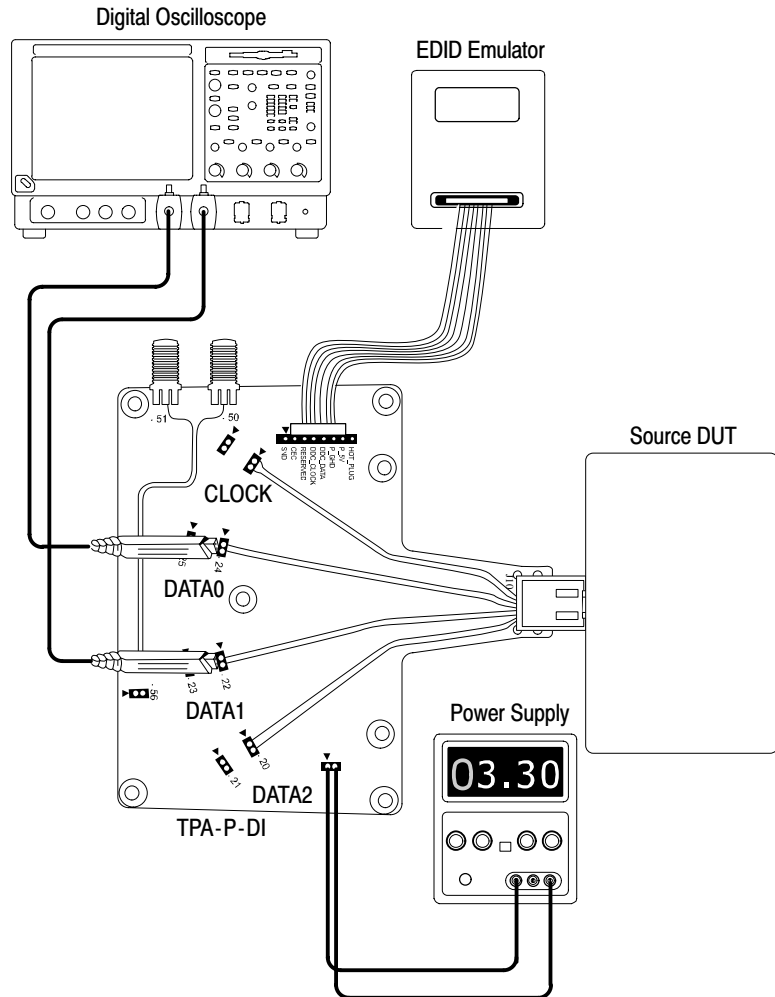

7. Click **View Waveform**.

Verify that the oscilloscope displays a similar waveform to the one displayed by the TDSHT3 software. If the displays are not similar, check your configuration and connections.

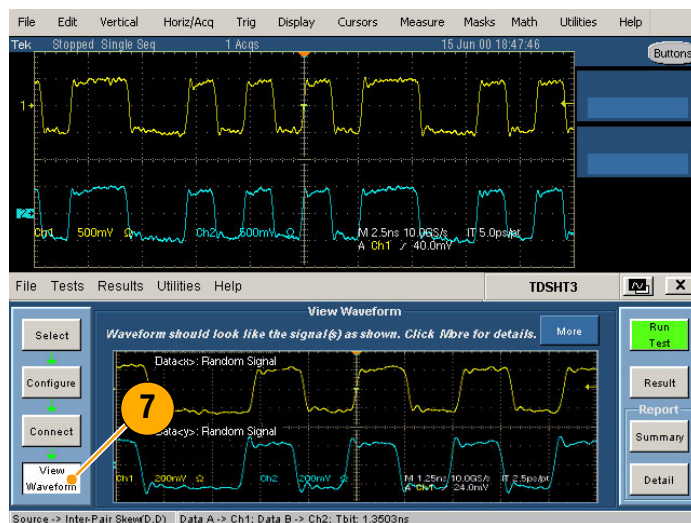

Recalculate the Tbit value:

8. Click **Configure** again.
9. Check that the software is set (default) to recalculate the Tbit value.
10. If your signal has too much jitter and noise, increase the value in this box (default = 100).
11. Click **Run Test** and then click **Continue** to run the test with the new Tbit value.
12. When the test completes, check the test results. For more information, see *Interpret the Test Result* on page 12.
13. To generate reports based on the tests that you ran, see *Generate and Print a Report* on page 14.

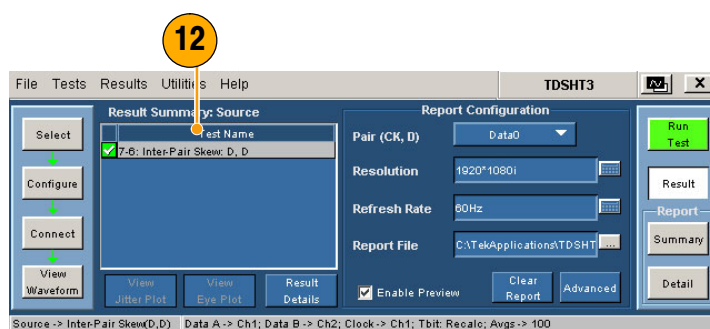
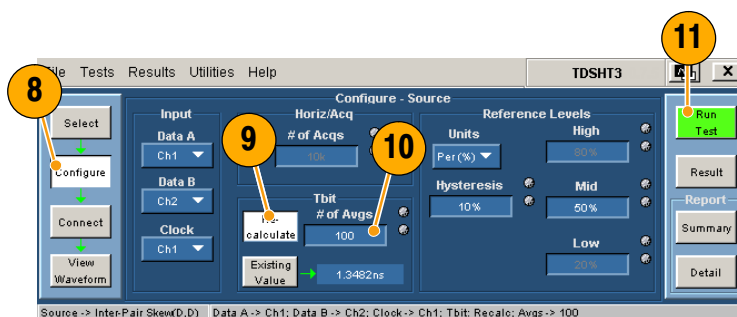

## Sink: Min-Diff Sensitivity Test

This test verifies that the sink device properly supports TMDS differential voltages at minimum levels.

Required equipment	Example
Digital Timing Generator	Tektronix DTG5274 with DTM30 output module
8 SMA cables	Tektronix 174-1341-00 1 meter or Tektronix 174-1428-00 1.5 meters
1 DC power supply, set to 5.0 V	Kenwood PW18-1.8AQ
1 input adapter	Tektronix TPA-R-TDR

1. Click **Select**.
2. Click the **Sink** tab.
3. Select **Min-Diff Sensitivity**.

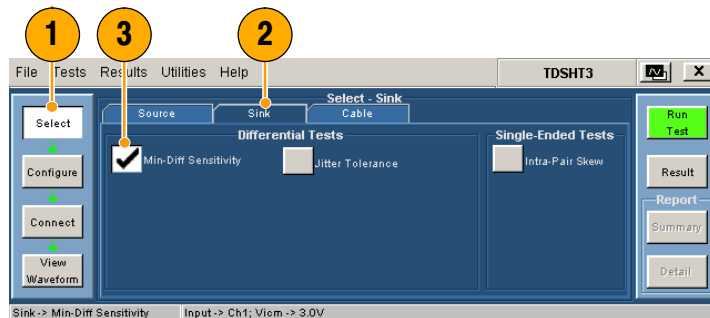

4. Click **Configure**. Change these values if needed. (You can generally use the default values.)

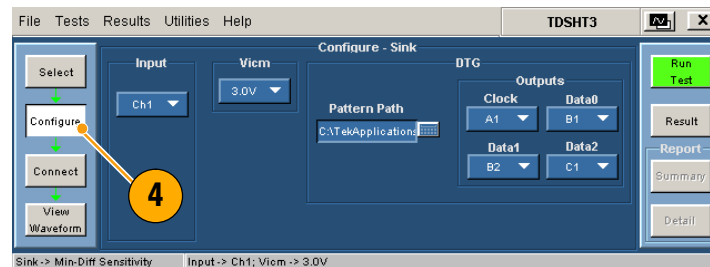

5. Click **Connect**.

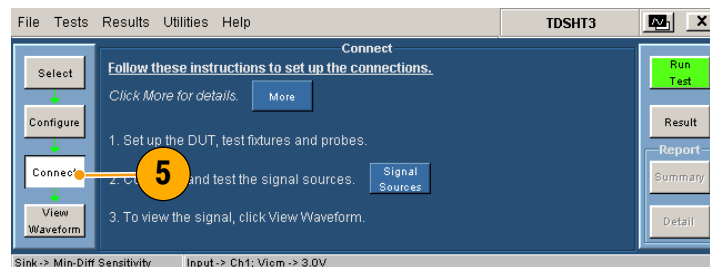



6. Connect and configure the equipment:

- Connect the test equipment as shown in the diagram.
- Connect the DTG and oscilloscope according to the *Enable Remote Control of Test Equipment* procedure on pages 32 through 35.

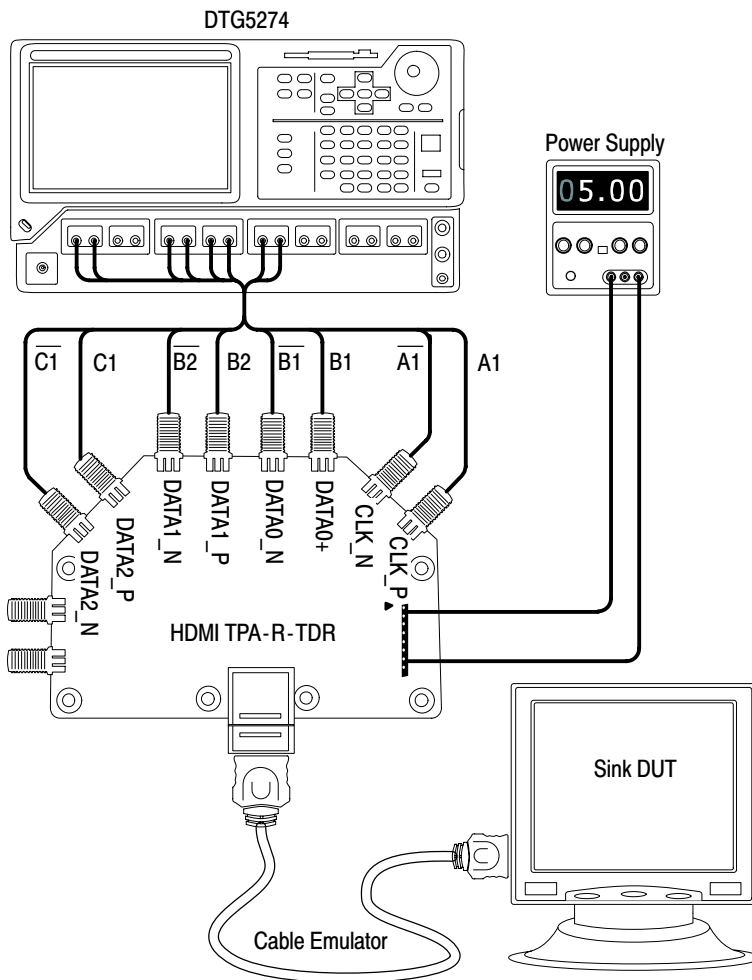

7. Click **Run Test**.

8. Follow the series of on-screen messages.
9. When the test completes, check the test results. For more information, see *Interpret the Test Result* on page 12.
10. To generate reports based on the tests that you ran, see *Generate and Print a Report* on page 14.

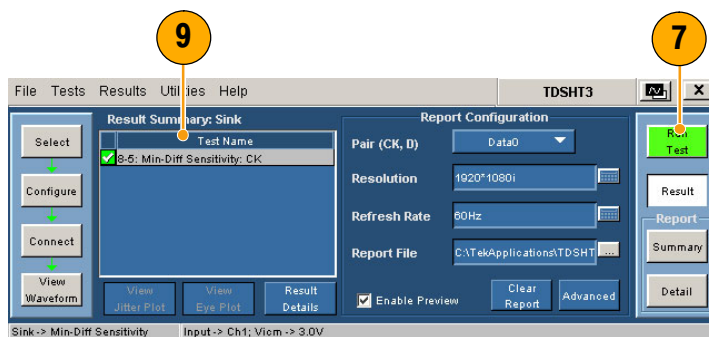

**NOTE.** When you run sink or cable tests, a warning about GPIB Bus Timing appears. If you are sure that the bus timing parameter is set to 2  $\mu$ sec, click OK to continue. Otherwise, click Cancel and change the bus timing parameter according to the procedure on page 34.

## Sink: Jitter Tolerance Test

This test verifies that your device supports the maximum allowed TMDS clock jitter.

Required equipment	Example
Digital Timing Generator	Tektronix DTG5274 with DTM30 output module
Arbitrary Waveform Generator	Tektronix AWG710 or AWG710B
12 SMA cables	Tektronix 174-1341-00 1 meter or Tektronix 174-1428-00 1.5 meters
1 cable emulator	JAE DC1P19ST02700AA for 27 MHz tests JAE DC1P19ST07425AA for 74.25 MHz tests
2 bias tees	Mini-circuits ZFBT-4R2GW
1 DC power supply, set to 5 V	Kenwood PW18-1.8AQ
2 input adapters	Tektronix TPA-R-TDR Tektronix TPA-R-DI

1. Click **Select**.
2. Click the **Sink** tab.
3. Select **Jitter Tolerance**.

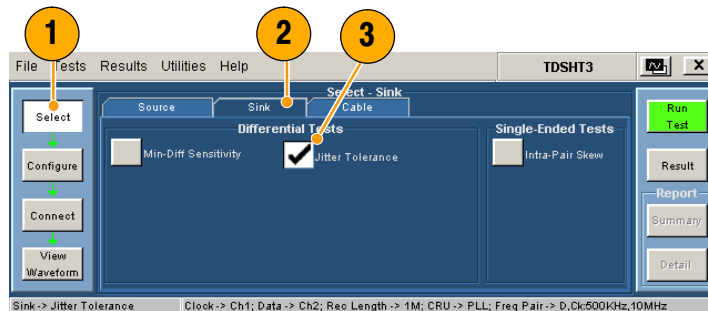

4. Click **Configure**. Change these values if needed. (You can generally use the default values.)

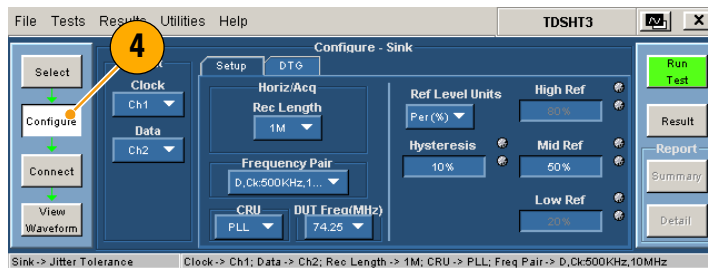

5. Click the **DTG** tab and configure which DTG outputs will provide the clock and data input signals.

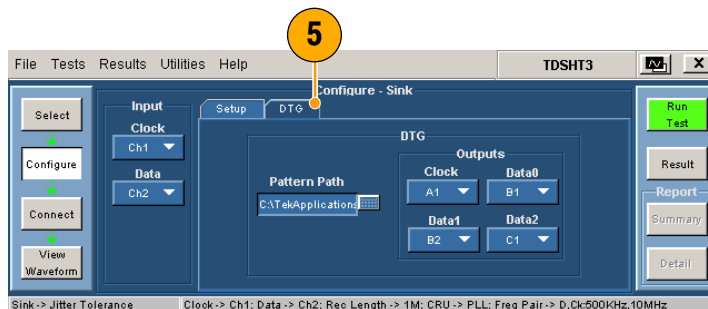

6. Click **Connect**.

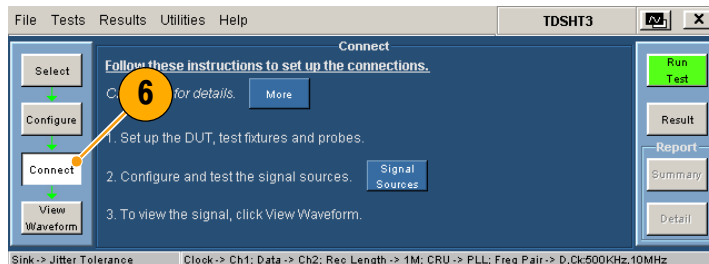

7. Connect and configure the equipment:

- Connect the test equipment as shown in the setup diagram.
- When connecting the test fixture to the DUT, use a cable emulator specified for the pixel clock rate being tested.
- Connect the DTG, AWG, and oscilloscope according to the *Enable Remote Control of Test Equipment* procedure on pages 32 through 35.
- Configure the DUT to receive the HDMI input signal.

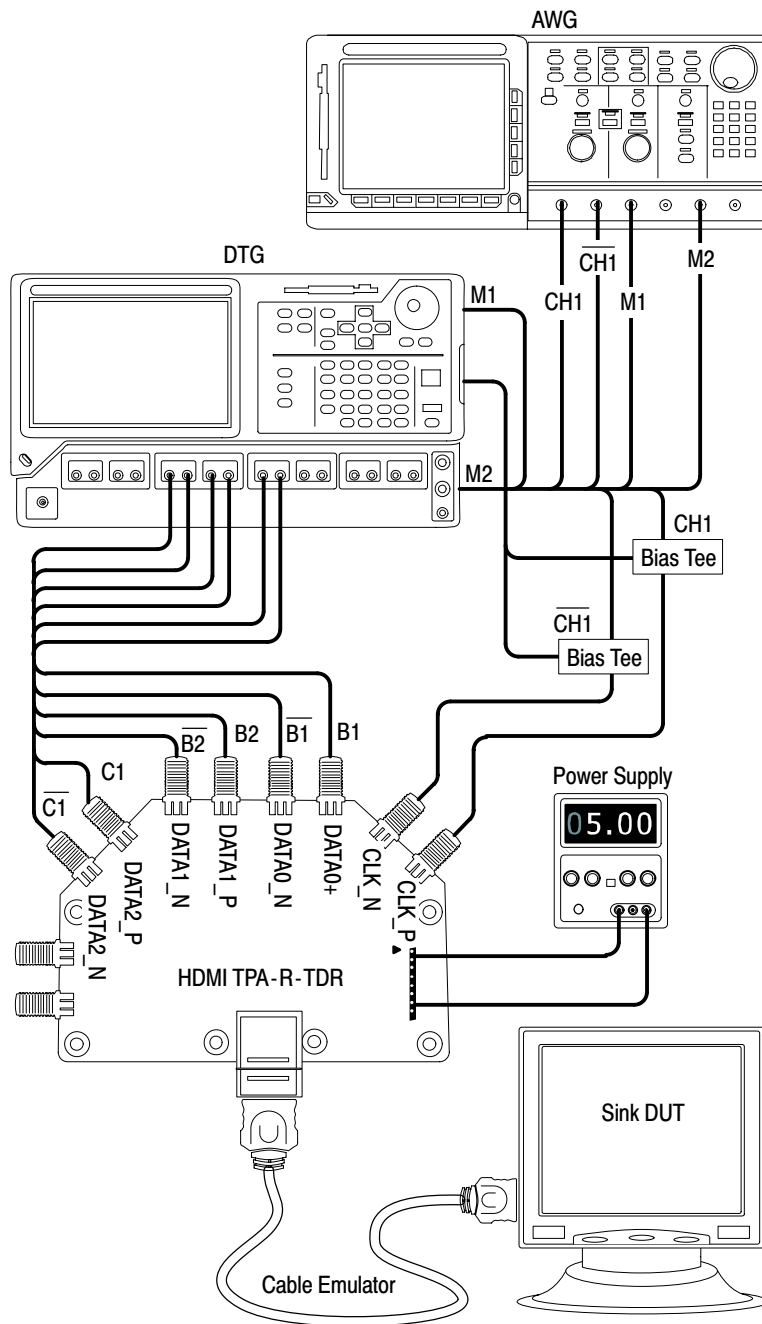

8. Click **Run Test**.
9. Follow the series of on-screen messages.
10. When the test completes, check the test results. For more information, see *Interpret the Test Result* on page 12.
11. To generate reports based on the tests that you ran, see *Generate and Print a Report* on page 14.

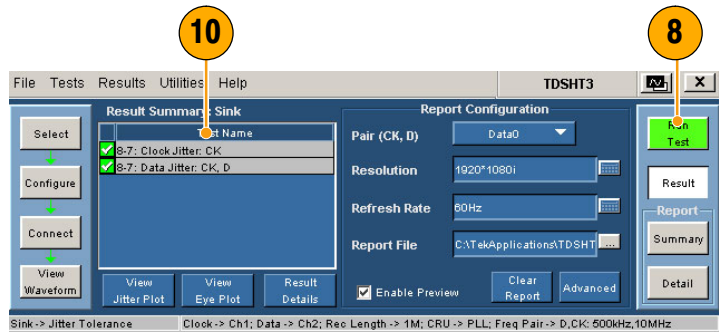

**NOTE.** When you run sink or cable tests, a warning about GPIB Bus Timing appears. If you are sure that the bus timing parameter is set to 2  $\mu$ sec, click OK to continue. Otherwise, click Cancel and change the bus timing parameter according to the procedure on page 34.

## Cable: Eye Diagram Test

This test verifies that the cable assembly outputs a compliant data eye.

Required equipment	Example
Digital Timing Generator	Tektronix DTG5274 with DTM30 output module
2 differential probes; Ground lead	Tektronix P7330 or later; Tektronix 196-3469-00
8 SMA cables	Tektronix 174-1341-00 1 meter or Tektronix 174-1428-00 1.5 meters
1 DC power supply, set to 3.3 V	Kenwood PW18-1.8AQ
2 input adapters	Tektronix TPA-P-DI Tektronix TPA-R-DI Tektronix TPA-P-TDR

1. Click **Select**.
2. Click the **Cable** tab.

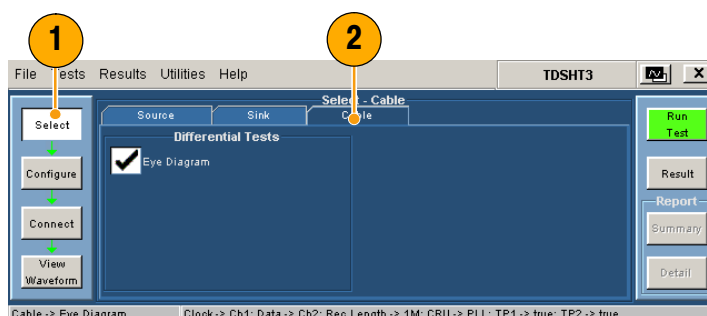

3. Click **Configure**. Change the values if needed. (You can generally use the default values.)

- **Test Points.** For the first cable that you test, select TP1 and TP2 to verify both the input test signal (TP1) and the output of the cable (TP2). For successive cable tests, clear TP1.
- **CRU.** Ensure that PLL (default) is selected for compliance testing.

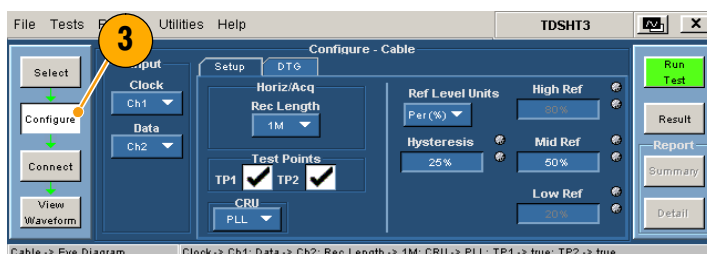

4. Click the **DTG** tab. Configure which DTG outputs will provide the clock and data test signals.

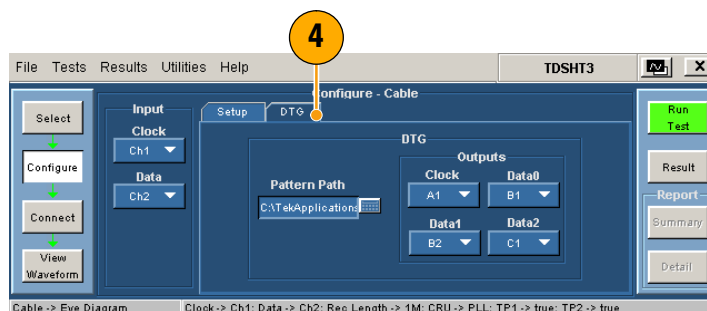

5. Click **Connect**.

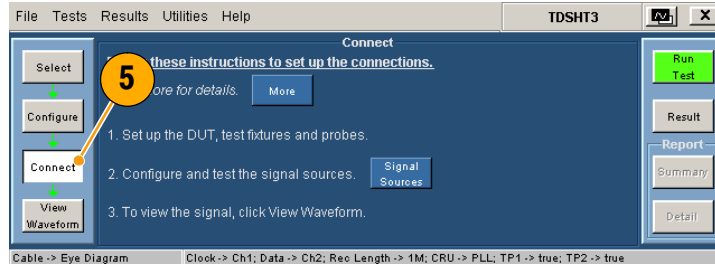

6. Connect and configure the equipment to verify the test signal input:

- Connect the test equipment as shown in the TP1 setup diagram.
- Connect the DTG and oscilloscope according to the *Enable Remote Control of Test Equipment* procedure on pages 32 through 35.

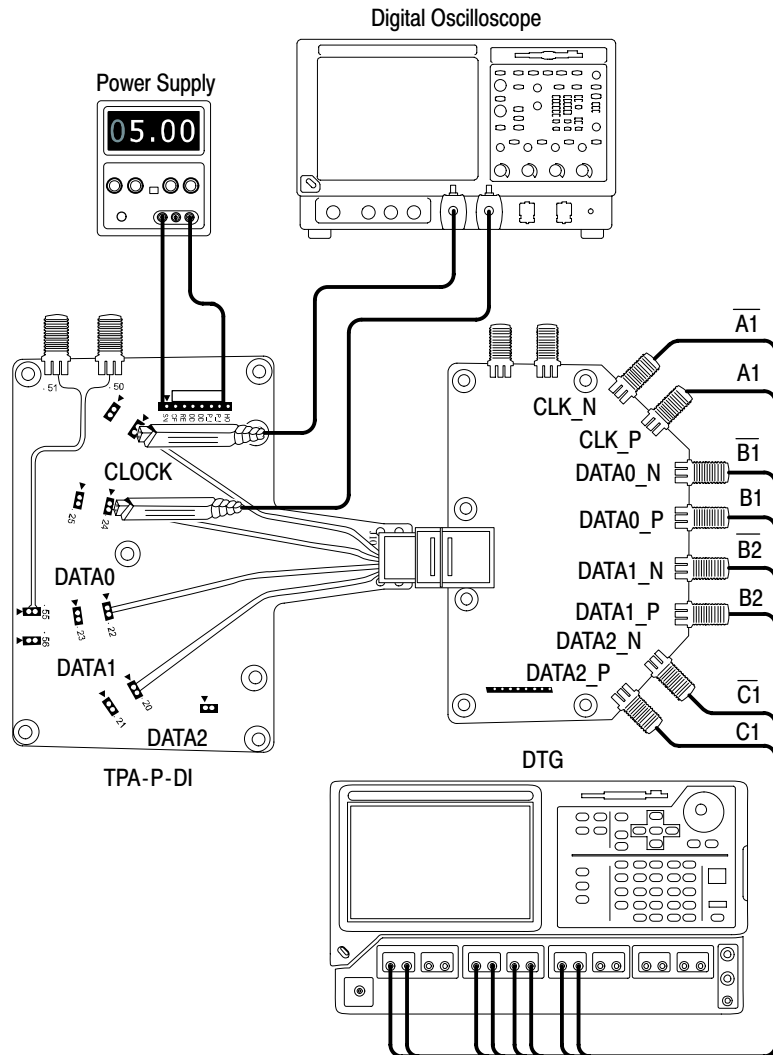

**NOTE.** When you run sink or cable tests, a warning about GPIB Bus Timing appears. If you are sure that the bus timing parameter is set to 2  $\mu$ sec, click OK to continue. Otherwise, click Cancel and change the bus timing parameter according to the procedure on page 34.

7. Click **Run Test**.
8. Follow the series of on-screen messages.
9. When the test completes, check the test results. These results confirm that the test signal input is compliant. For more information, see *Interpret the Test Result* on page 12.

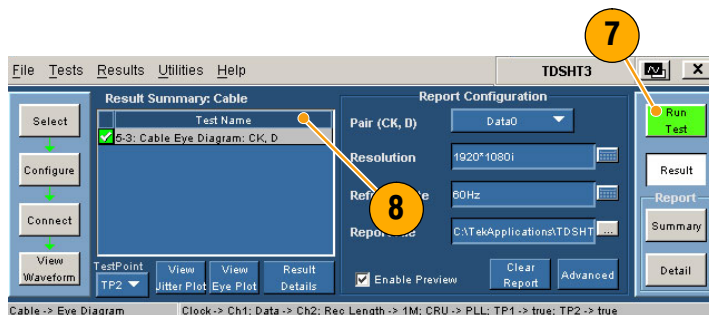

10. Remove the TPA-P-DI adapter and add the TPA-R-DI adapter as shown in the diagram.
11. Add the cable DUT between the TPA-R-TDR and TPA-R-DI adapters.
12. Click **Run Test**.
13. When the test completes, check the test results. Pass indicates HDMI compliance of the cable DUT. For more information, see *Interpret the Test Result* on page 12.
14. Click **Configure** and set the test point to TP2.
15. Replace the cable with another cable DUT and click **Run Test**.
16. To generate reports based on the tests that you ran, see *Generate and Print a Report* on page 14.

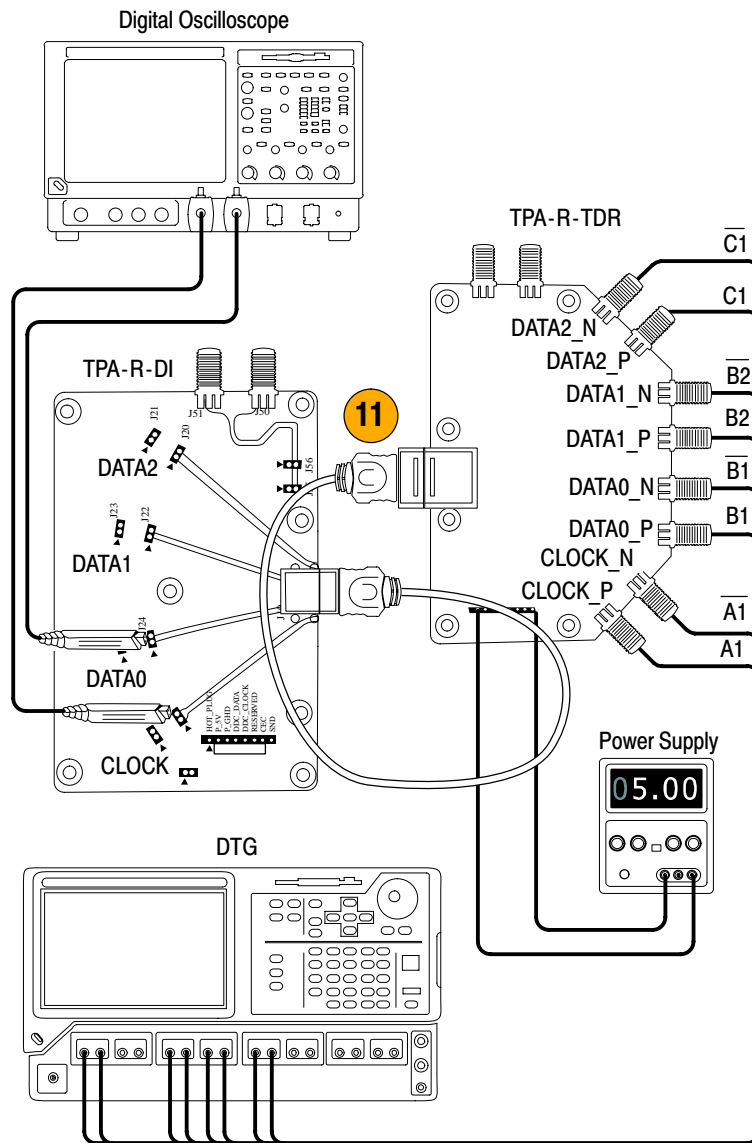

## Enable Remote Control of Test Equipment

If you are using the specified Tektronix DTG and AWG models, the TDSHT3 software can configure the connected test equipment automatically as you run tests. If you are using another DTG or AWG, you must configure the test equipment manually.

Use this procedure to:

- Connect the AWG and DTG for remote control
- Configure the GPIB address for remote control

You will need:

- Tektronix DTG5274, Tektronix AWG710
- Tektronix 7000 series digital oscilloscope
- National Instruments GPIB-USB-B with the included software, NI-488.2 for Windows

### Install NI-488.2 for Windows

**NOTE.** If you already have NI-488.2 installed on your oscilloscope, ensure that you have the version and installation parameters that are described in step 1. If you do not, then uninstall NI-488.2, and install it according to step 1.

1. Install NI-488.2 for Windows (version 2.1 or later).

During installation:

2. Do not install NI-VISA.
3. Install the Measurement & Automation Explorer.
4. When prompted, enable the GPIB-USB interface.
5. Restart the oscilloscope.

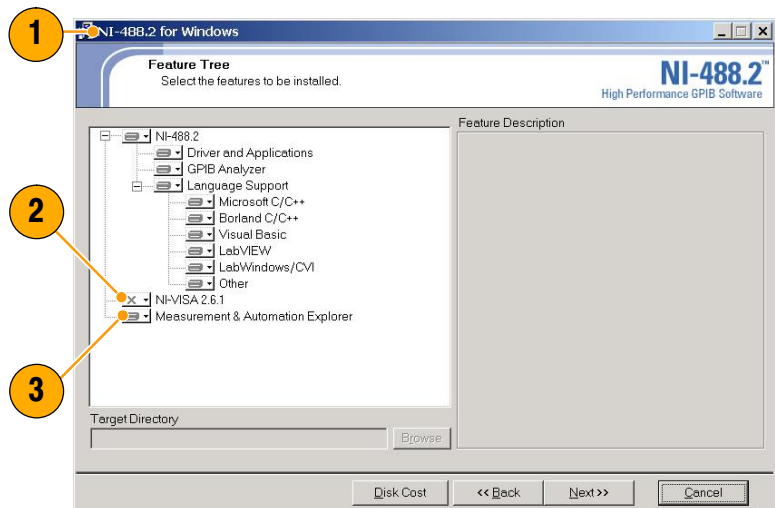



## Connect the Equipment

- Connect the USB-GPIB controller to the oscilloscope USB port. The oscilloscope operating system detects the USB-GPIB controller and installs the driver for it.

- Using GPIB cables, connect (stack) the DTG and AWG GPIB connectors to the GPIB port of the GPIB controller.
 

If your test does not use the AWG, connect the GPIB-USB-B between the oscilloscope and the DTG, omitting the stacked connector from the AWG.

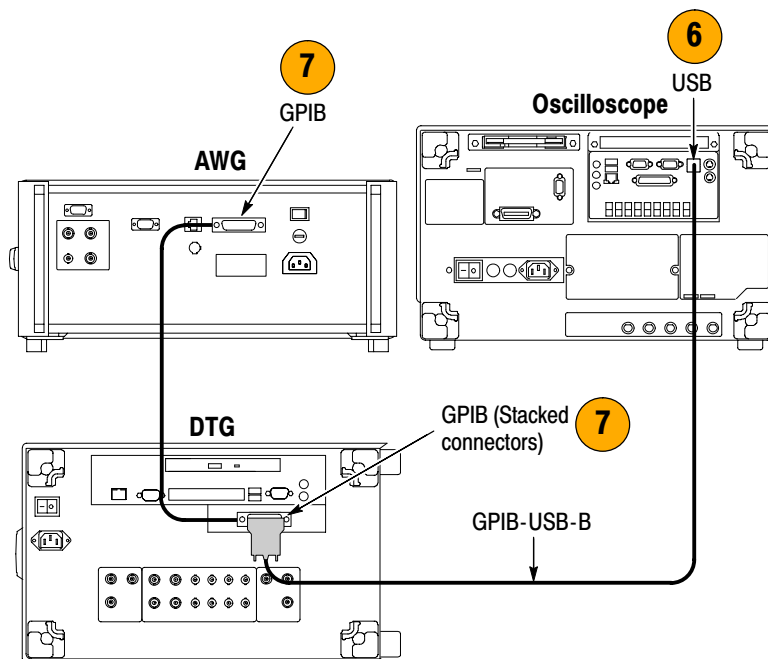

## Verify the Equipment Connections

- Open the Measurement & Automation Explorer that was installed with the NI-488.2 software.
- In the Configuration pane, under Devices and Interfaces, right-click the GPIB device.
- Click **Scan for Instruments**.
- Note the GPIB Instrument Number and the Primary Address.
- Right-click the instrument and click **Communicate with Instrument**.
- Click **Query** and check that **\*IDN?** describes the correct equipment.

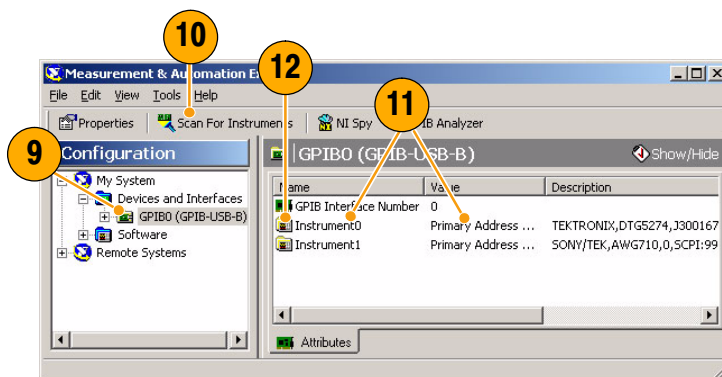

## Set the GPIB Bus Timing

14. Right-click the GPIB device and click **Properties**.

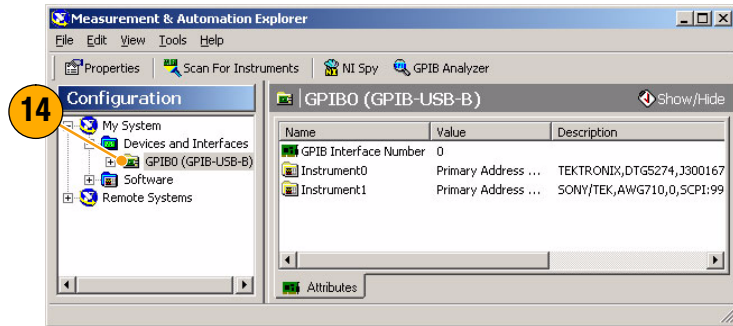

15. Click the **Advanced** tab.

16. In the Bus Timing list, select 2μsec.

17. Click **OK**. (Be sure that you complete the procedure through step 28, where you will exit the software and restart the oscilloscope.)

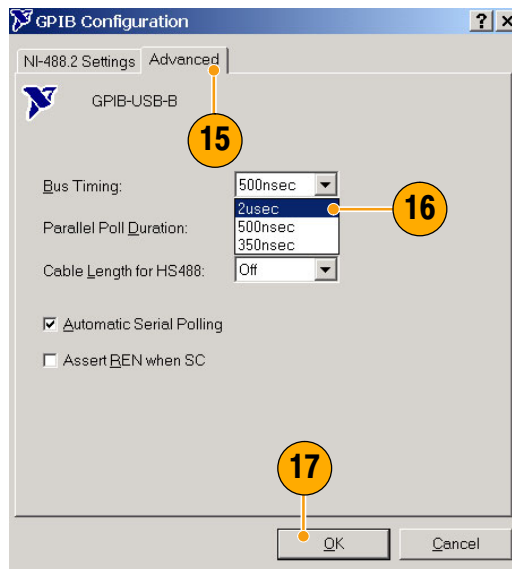

## Configure the GPIB Address

18. Start the TDSHT3 software.

19. Click **Select**.

20. Click the **Sink** tab.

21. Select a Differential test, such as **Jitter Tolerance**.

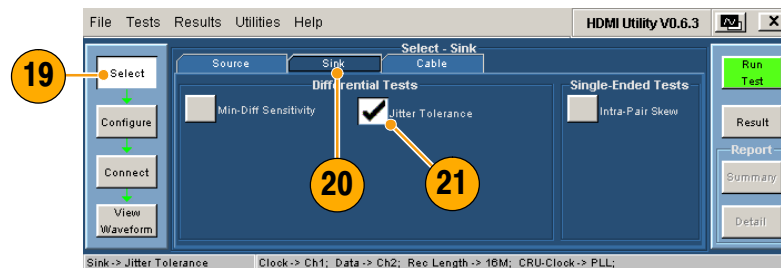

22. Click **Connect**.

23. Click **Signal Sources**.

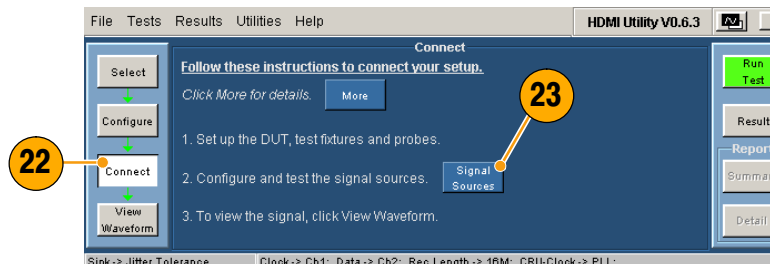

For the Tektronix DTG5274 generator:

24. Click the **DTG** tab.

25. Click **GPIB**.

26. Click the **AWG** tab and repeat.

27. Click **Test Conn** and look for a message that the connection is successful.

28. Exit the TDSHT3 software and restart the oscilloscope.

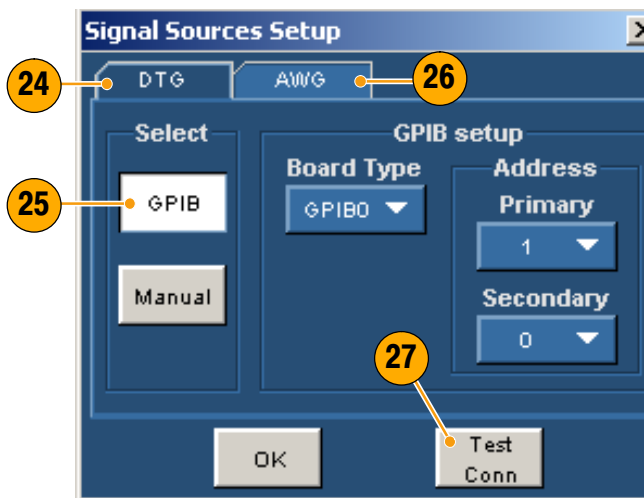

# Index

## A

- Acquisition, 7
- Address, Tektronix, iv
- Advanced, 15
- APP button, 8
- Application examples, 18
  - Cable tests, Eye Diagram, 29
  - Sink tests
    - Jitter Tolerance, 26
    - Min-Diff Sensitivity, 24
  - Source tests
    - Inter-Pair Skew, 21
    - Select All, 18
- AWG setup, 32

## B

- Buttons, 5

## C

- Cable, Eye Diagram test, 29
- Cable emulator, 27
- Calibrate probes, 3
- Clear report, 15
- Client pane, 5
- Close the application, 4
- Configure, 10
- Configure button, 9
- Configure test equipment, 32
- Configure the GPIB address, 34
- Connect, 10
- Connect button, 9
- Connect test equipment, 32
- Connections, 1
- Contact Tektronix, iv
- CSV file, 14

## D

- Deskew, 20
- Detail, 17
- Detailed report, 15
- Device under test type, 5
- Documentation, iii
- DTG setup, 32
- DTG5274, 35
- DUT Details, 16
- DUT ID, 16
- DUT type, 5

## E

- Edge trigger, 7
- EDID emulator, 20
- Enable Preview, 15, 17
- Error codes, 12
- Execution pane, 5
- Exit button, 4
- Exit the software, 4

## F

- Factory defaults, 10
- File
  - Exit, 4
  - Preferences, 7
  - Run application, 2
- Fine button, 7

## G

- General purpose knob, 7, 10
- Generate a report, 14
- Generator setup, 32
- Get acquainted with the application, 5
- GPIB, 35
- GPIB address, 34
- GPIB bus timing, 34

## H

- Half Screen, 13
- HDMI standards conformance, iii
- Hide icon, 8
- Hide the application, 8
- How to
  - Install your software, 1
  - Make tests, 9
  - Operate the Application, 9

## I

- Installation, 1
- Inter-Pair Skew test, 21
- Interface, 5
- Intersymbol interference, 7

## J

- Jitter Tolerance test, 26

## K

- Key features, iii
- Keyboard, 5
- Knob, 7, 10

## M

- Make tests, 9
- Menu bar, 5
- Menus, 5
- Min-Diff Sensitivity test, 24
- Mouse, 5
- Multiple tests, 9

## N

- NI-488.2 for Windows, 32

## O

- Oscilloscope general purpose knob, 10

## P

- Pair, 15
- Pixel clock rates, 20
- Position eye mask in center, 7
- Preferences, 7
- Print a report, 14
- Product description, iii
- Product support, iv

## R

- Recalculate Tbit value, 23
- Refresh Rate, 15
- Related documentation, iii
- Remote control, 32
- Report File, 15
- Report file formats, 14
- Report summary, 14
- Resolution, 15
- Restore application, 8
- Result Details, 12
- Results, 12
- Results button, 9
- Return to the application, 8
- RGT format, 14
- RPL format, 14

RPT format, 14  
RTF format, 14  
Run Test, 11  
Run Test button, 9

## S

Select button, 9  
Select All, 9, 18  
Select multiple tests, 9  
Selection pane, 5  
Service support, contact information, iv  
Set preferences, 7  
Signal Sources, 35  
Sink, Differential  
    Jitter Tolerance test, 26  
    Min-Diff Sensitivity test, 24  
Software upgrades, iv  
Source, Data-Data, Inter-Pair Skew  
    test, 21  
Source tab, 9  
Source tests, Select All, 18  
Start the application, 2  
Status bar, 5

SVGA, 20

## T

Tbit value, 23  
Technical support, iv  
Tektronix, contact, iv  
TekVisa, 1  
Test Conn, 35  
Test equipment, 32, 33  
    Connect, 10  
    Setups, 1  
Test ID, 9  
Test ID 5-3, 29  
Test ID 8-5, 24  
Test ID 8-7, 26  
Test parameters, Configure, 10  
Test results, 12  
Tests, Process flow, 9  
Touch screen, 5  
TPA-P-DI, 1  
TPA-P-SE, 1  
TPA-R-DI, 1

TPA-R-SE, 1  
TPA-R-TDR, 1  
Trigger, 7

## U

Use oscilloscope settings for image  
    export, 16  
Use the interface, 5

## V

VGA, 20  
View test results, 12  
View Waveform, 11  
View Waveform button, 9  
Virtual keyboard, 5, 10  
Virtual keypad, 6

## W

Web site address, Tektronix, iv  
Width trigger, 7

